

Hans 5 40 (380x575)

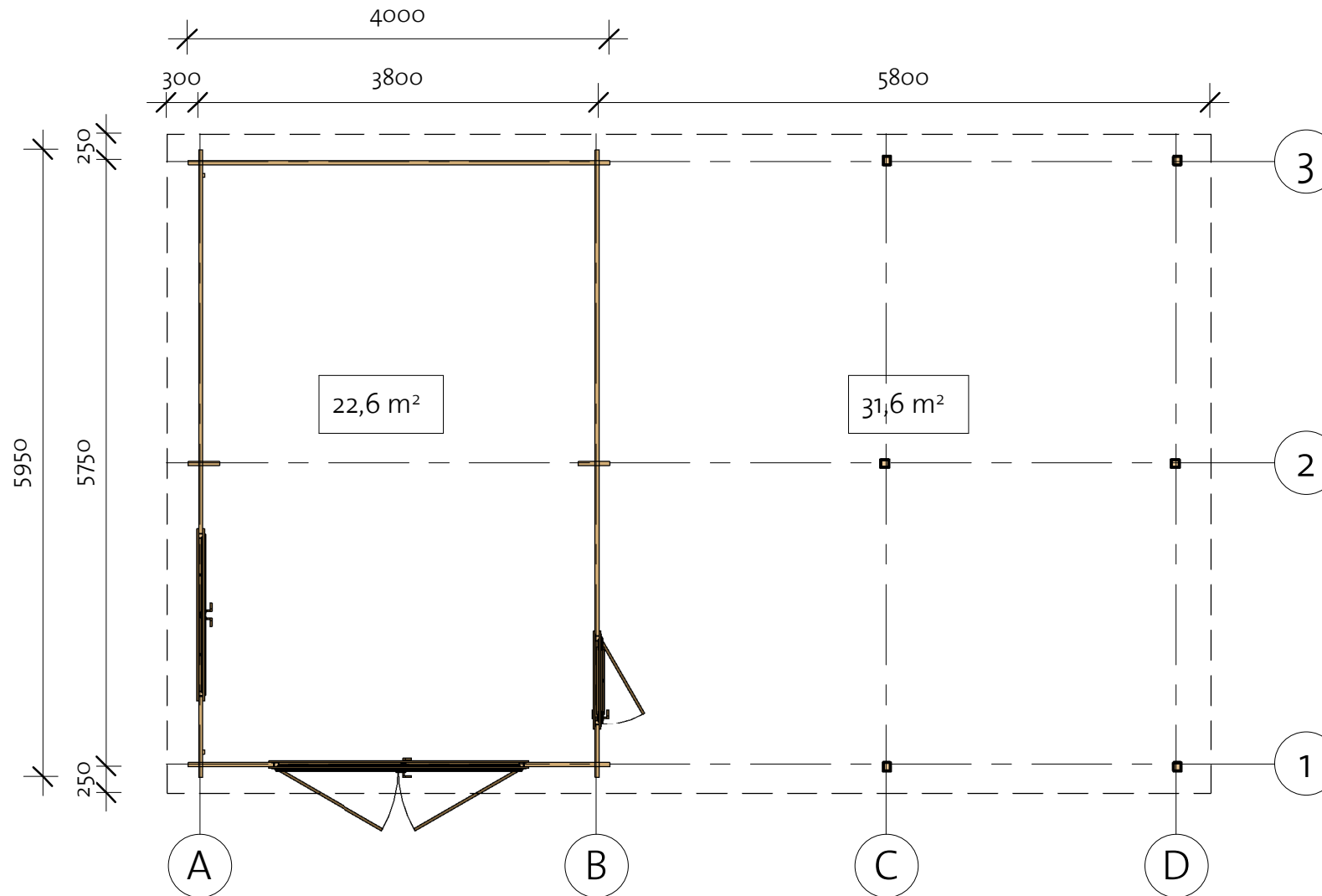

Hans 5 40 (380x575)

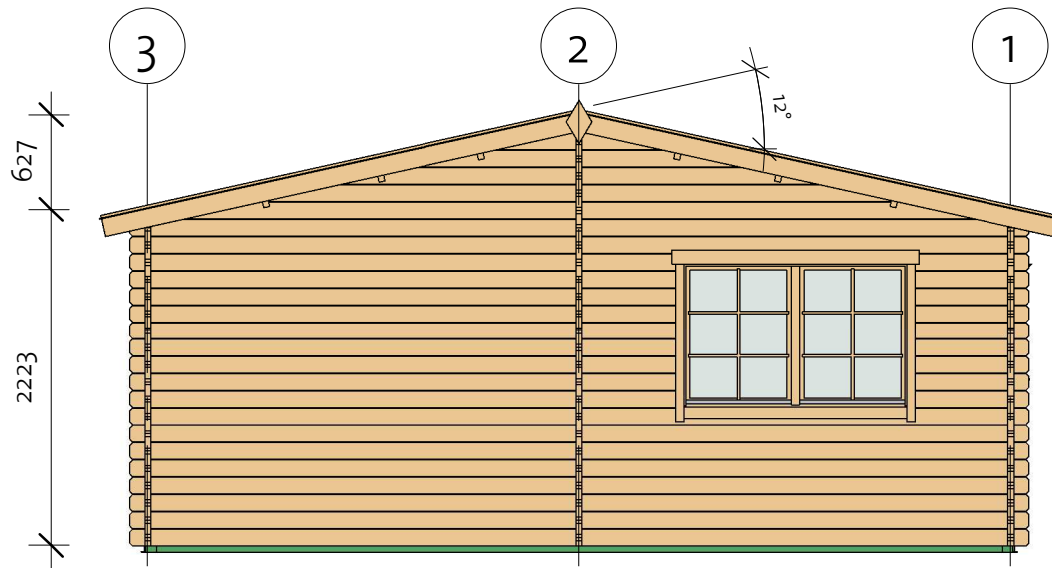

Hans 5 40 (380x575)

Foundation

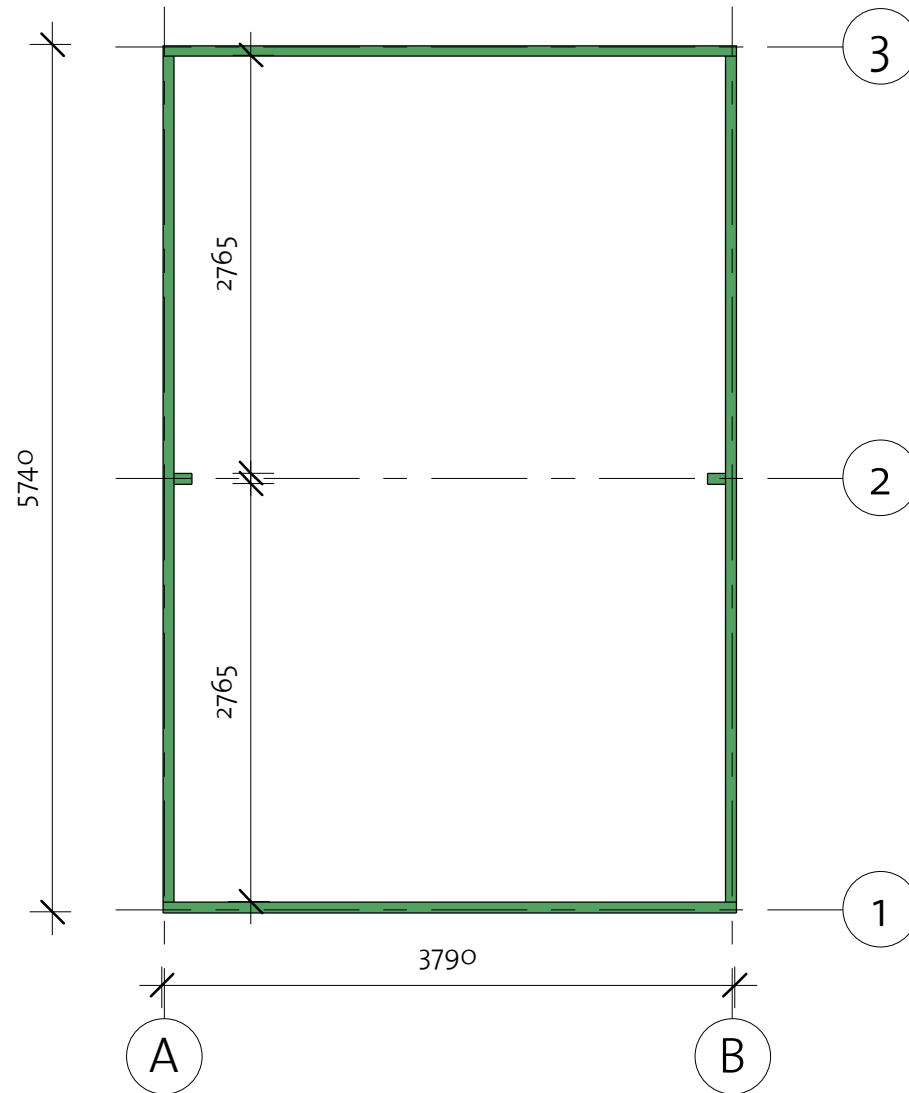

Impregnated foundation beams				
Mark	Type	Profile	Count	Length

IFB1	IFB 70x40		2	5600
IFB2	IFB 70x40		2	3790
IFB3	IFB 70x40		2	120

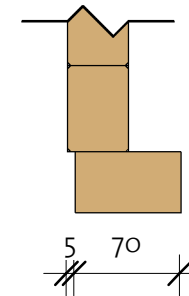

Hans 5 40 (380x575)

Foundation 2

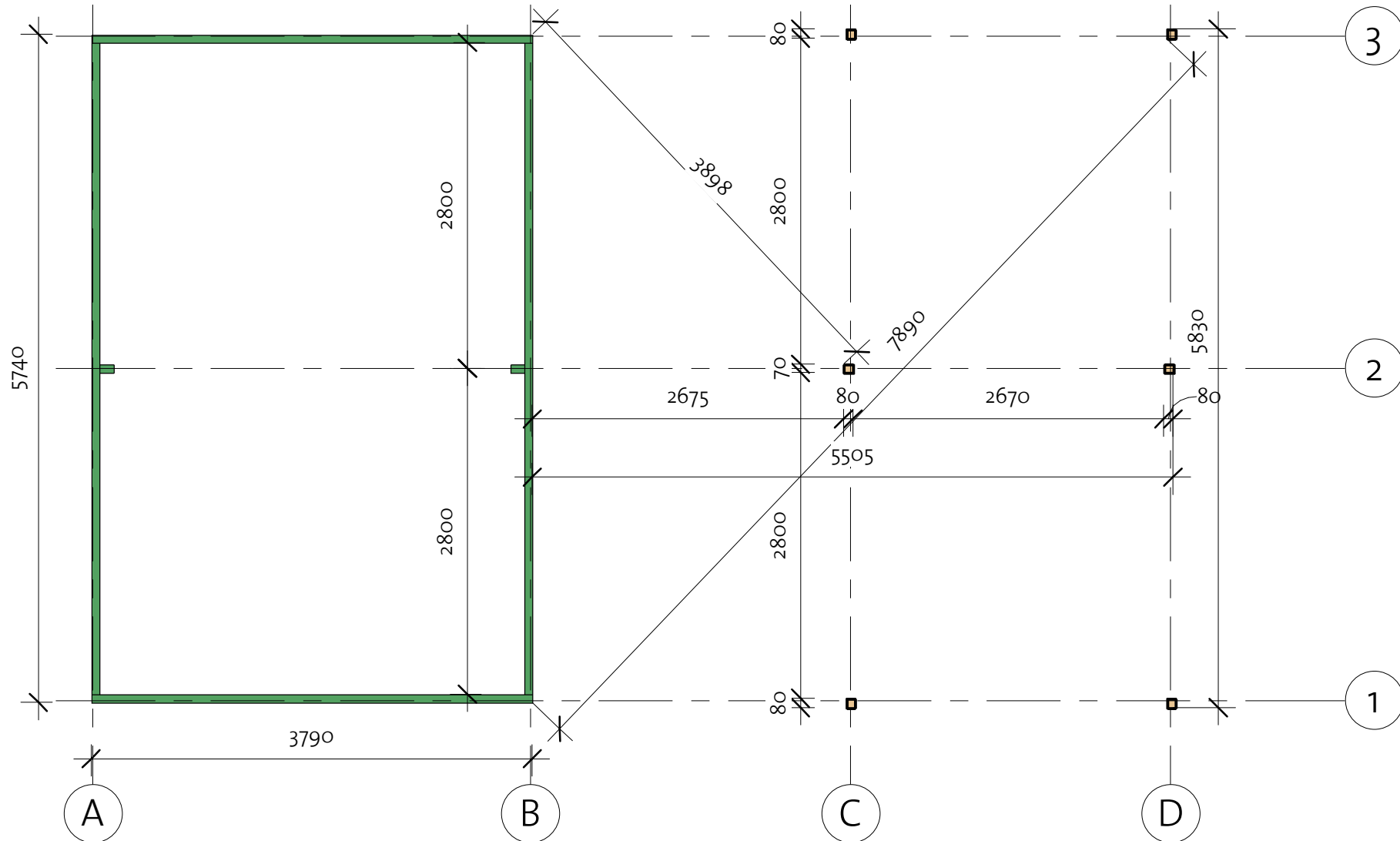

Hans 5 40 (380x575)

Wall 1

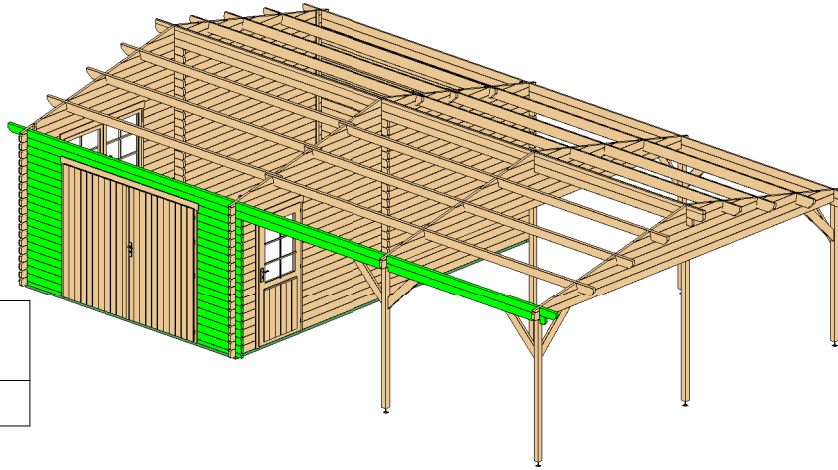

Wall 1			
Mark	Profile	Count	Cut Length

1BL-1	40x57	2	808
1LG-1	40x114	33	808
1LG-2	40x114	1	5620
1LG-3	40x114	1	3880
1LG-4	40x114	1	808
1TL-1	40x114	1	5820
1TL-2	40x114	1	4080

Log Profile Wall 1	
Profile	Profile

40x57	
40x114	

Log Profile Wall 1	
Profile	Profile

40x114	
--------	--

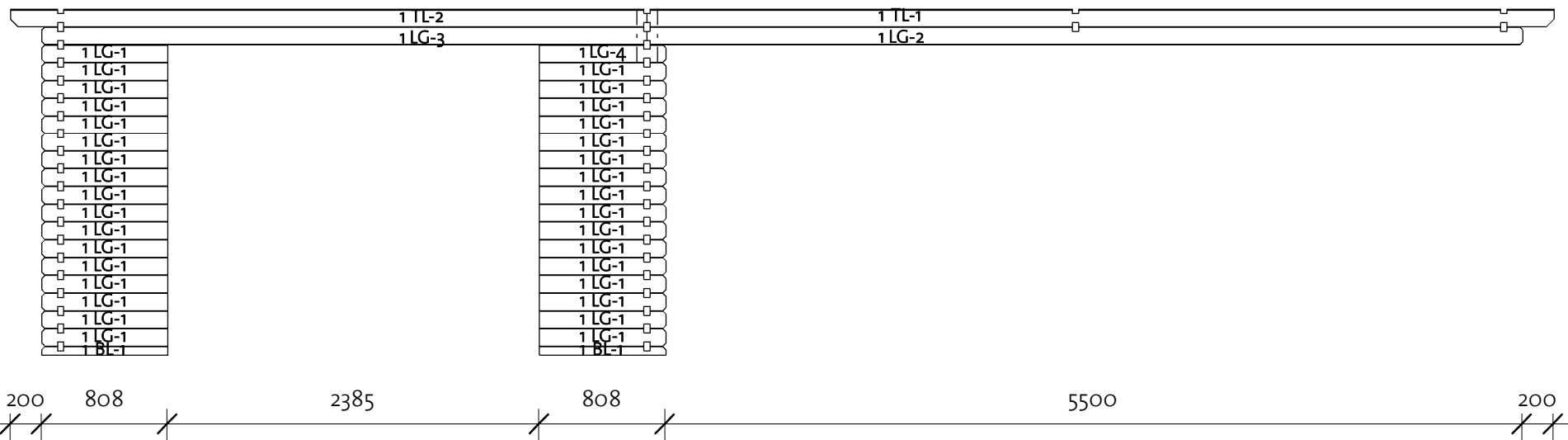



Hans 5 40 (380x575)

Wall 2

Log Profile Wall 2

Profile	Profile
---------	---------

40x57	
40x57	

Log Profile Wall 2

Profile	Profile
---------	---------

40x114	
--------	---

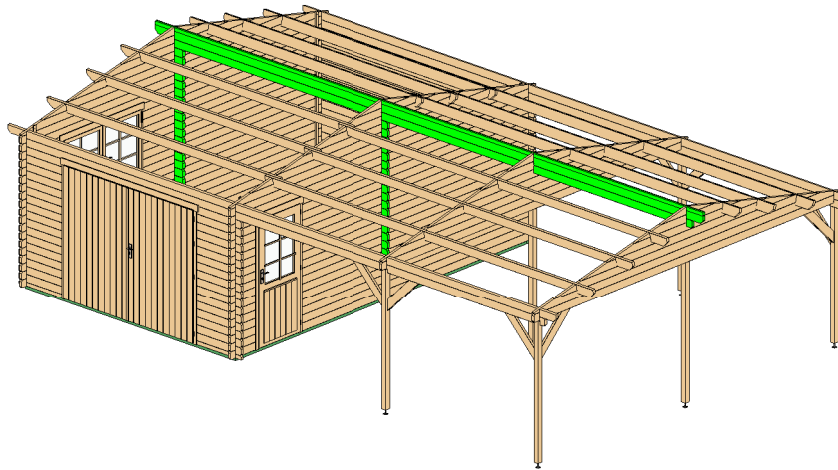

Wall 2

Mark	Profile	Count	Cut Length
------	---------	-------	------------

2BL-1	40x57	2	300
2LG-1	40x114	43	300
2LG-2	40x114	1	5620
2LG-3	40x114	1	3880
2LG-4	40x114	1	300
2LG-5	40x114	1	5820
2LG-6	40x114	1	4080
2TL-1	40x57	1	5820
2TL-2	40x57	1	4080

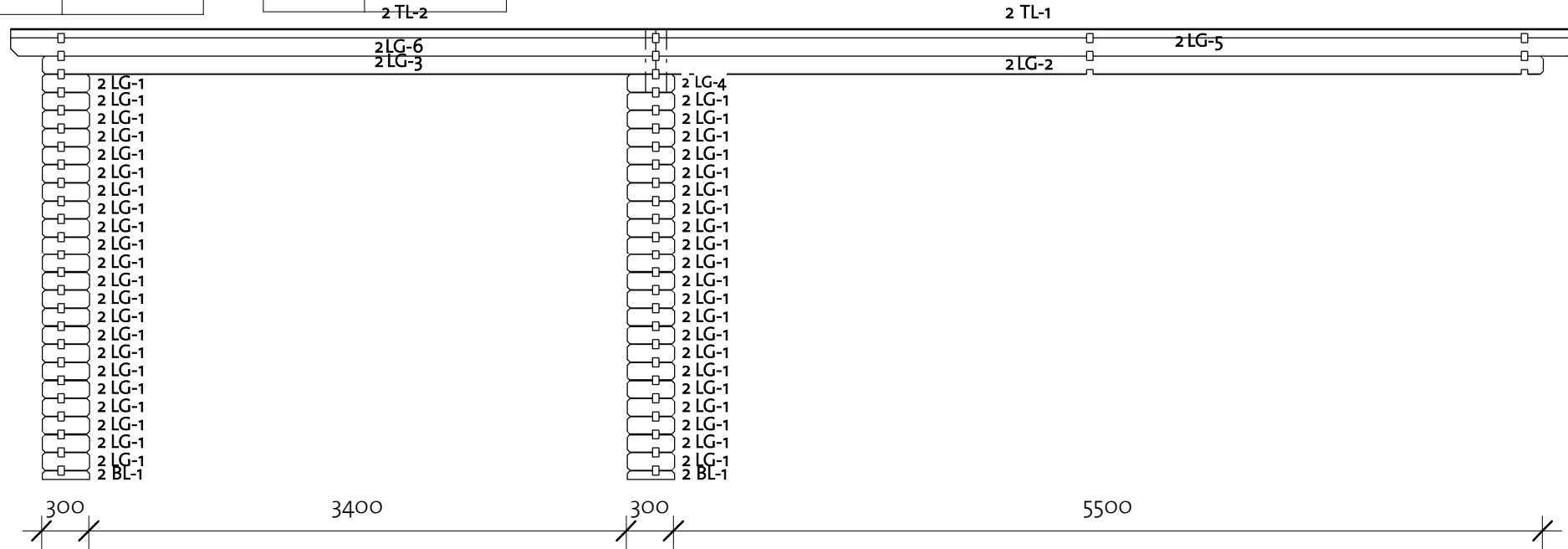

Hans 5 40 (380x575)

Wall A

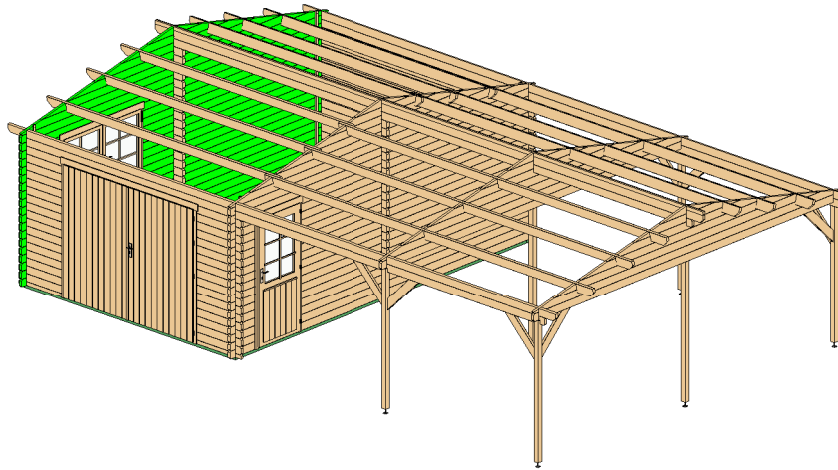

Wall A			
Mark	Profile	Count	Cut Length

ALG-1	40X114	9	778
ALG-2*	40X114	1	1032
ALG-3*	40X114	1	2063
ALG-4*	40X114	1	3093
ALG-5	40X114	9	3633
ALG-6*	40X114	1	4124
ALG-7*	40X114	1	5155
ALG-8	40X114	10	5950
ALG-9*	40X114	1	5950

* Gable - delivered premounted

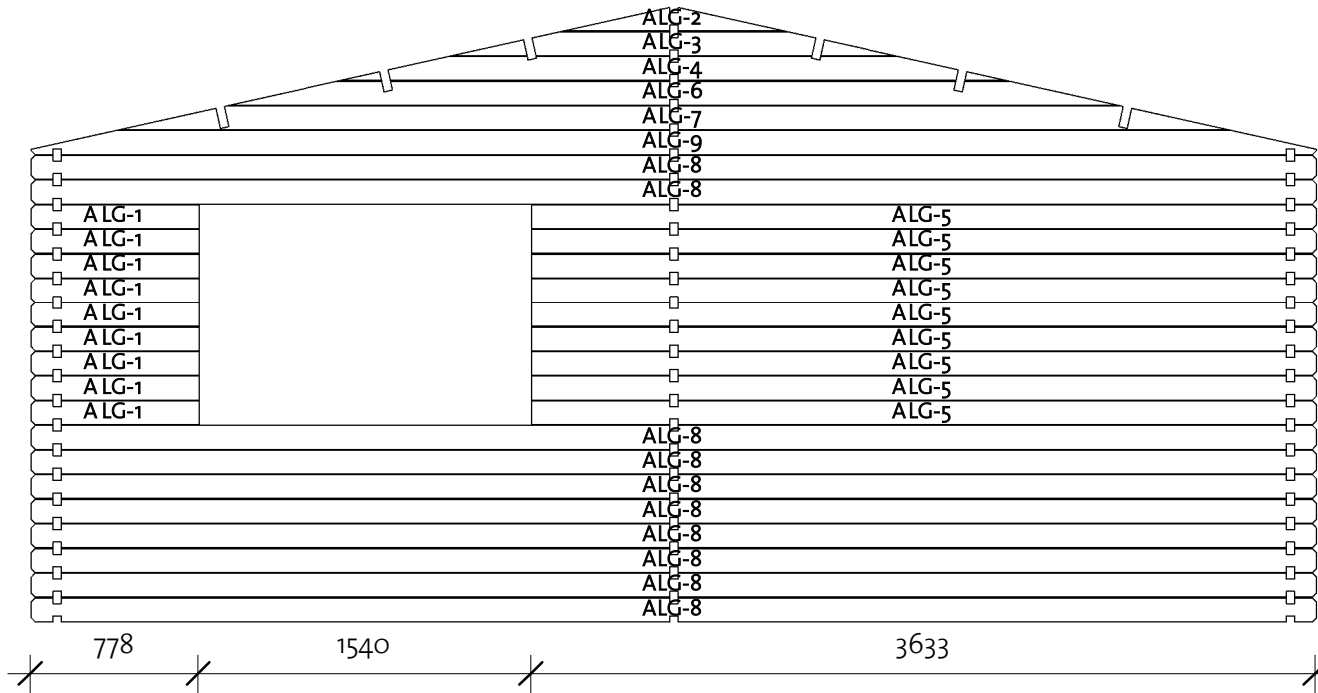

Log Profile Wall A	
Profile	Profile

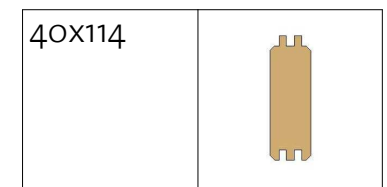

Hans 5 40 (380x575)

Wall B

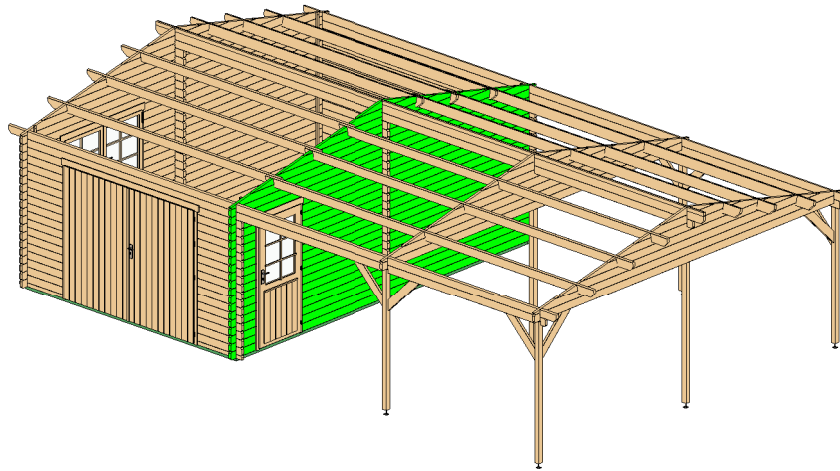

Wall B			
Mark	Profile	Count	Cut Length

BLG-1	40X114	17	500
BLG-2*	40X114	1	1032
BLG-3*	40X114	1	2063
BLG-4*	40X114	1	3093
BLG-5*	40X114	1	4124
BLG-6	40X114	17	4600
BLG-7*	40X114	1	5155
BLG-8	40X114	2	5950
BLG-9*	40X114	1	5950

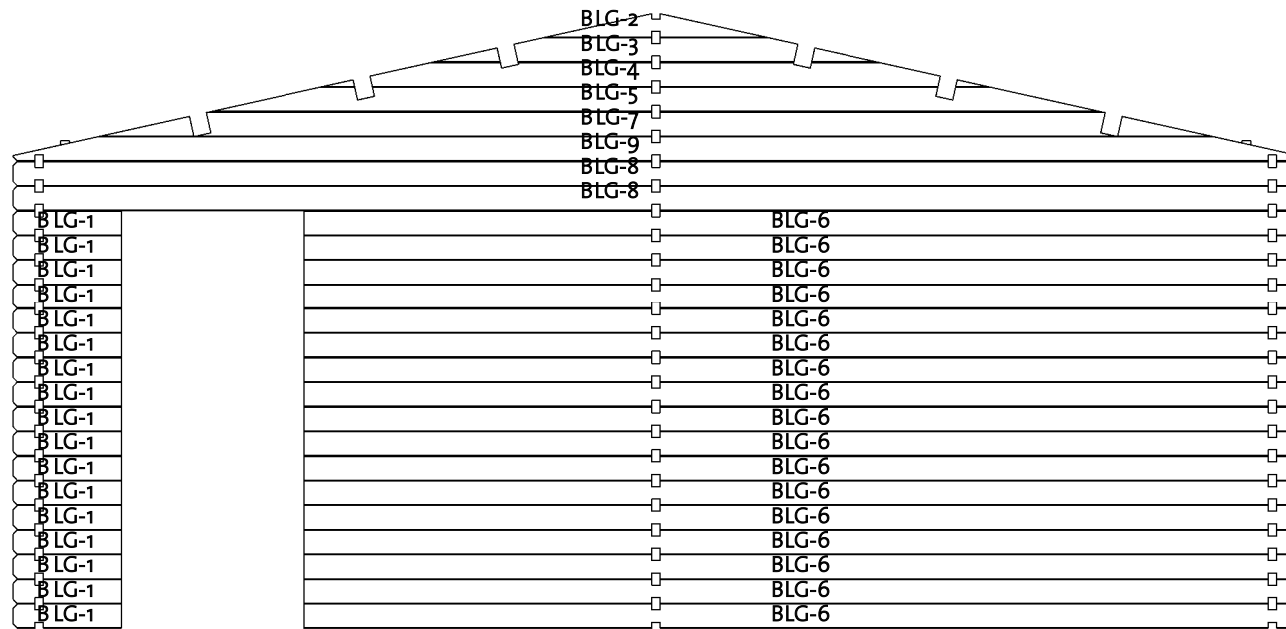

* Gable - delivered premounted

Log Profile Wall B	
Profile	Profile

40X114	
--------	--



92111021_210405

Hans 5 40 (380x575)

Wall C

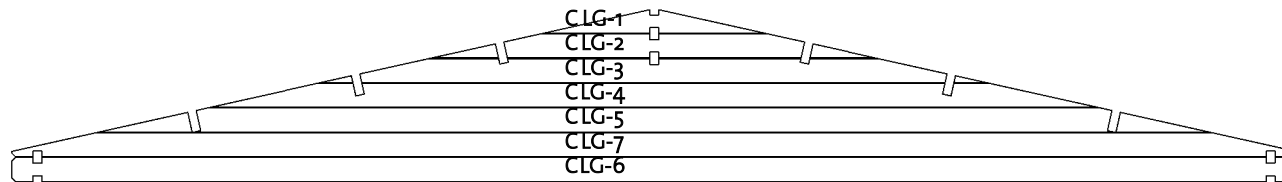
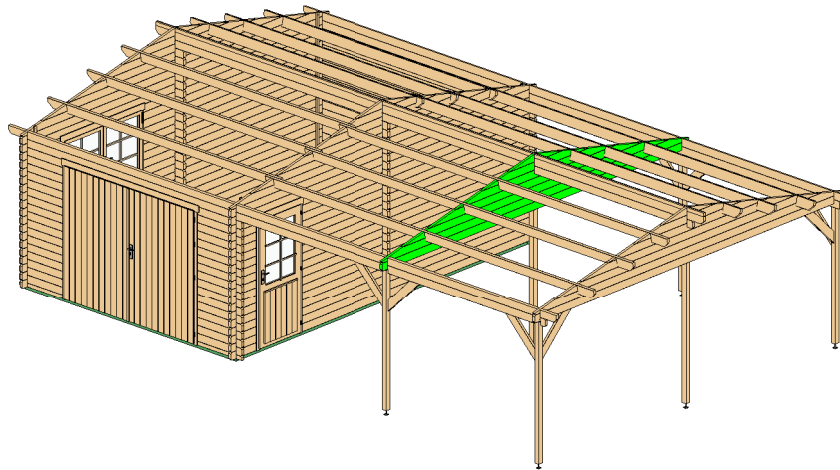

Wall C			
Mark	Profile	Count	Cut Length

CLG-1*	40X114	1	1032
CLG-2*	40X114	1	2063
CLG-3*	40X114	1	3093
CLG-4*	40X114	1	4124
CLG-5*	40X114	1	5155
CLG-6	40X114	1	5950
CLG-7*	40X114	1	5950

* Gable - delivered premounted

Log Profile Wall C

Profile

Profile

40X114

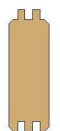

Hans 5 40 (380x575)

Wall D

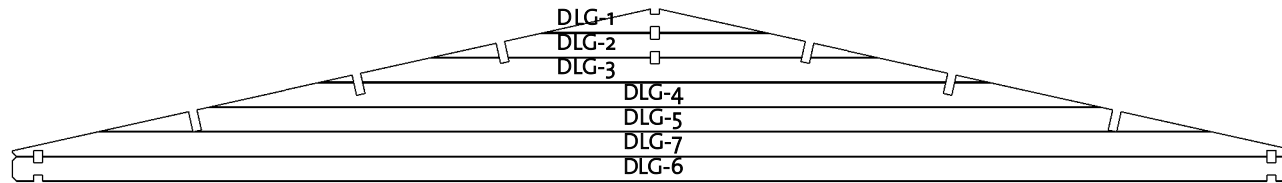
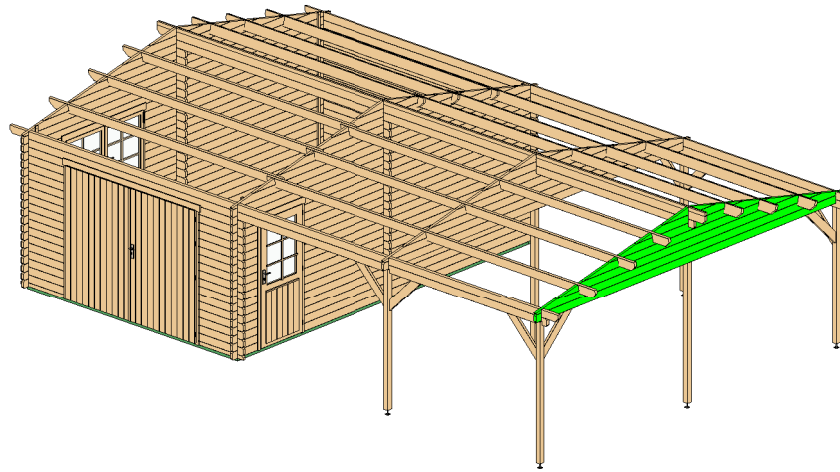

Wall D			
Mark	Profile	Count	Cut Length

DLG-1 *	40x114	1	1032
DLG-2 *	40x114	1	2063
DLG-3 *	40x114	1	3093
DLG-4 *	40x114	1	4124
DLG-5 *	40x114	1	5155
DLG-6	40x114	1	5950
DLG-7 *	40x114	1	5950

* Gable - delivered premounted

Log Profile Wall D	
Profile	Profile



40x114	
--------	---

Hans 5 40 (380x575)

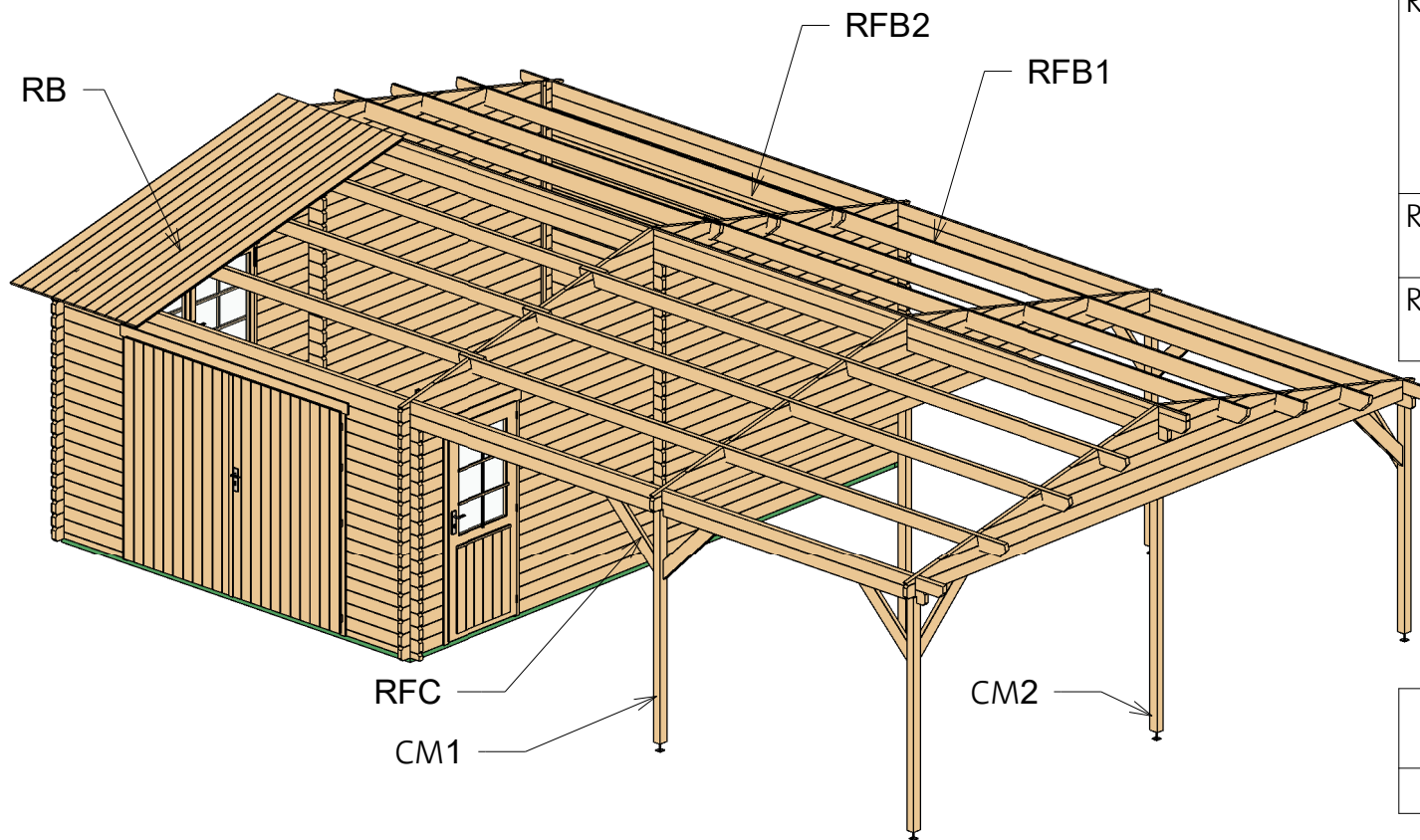
Roof 1



Roof				
Mark	Type	Profile	Count	Length

RB	17x114		176	3197
RFB1	Beam 40x143		6	5940
RFB2	Beam 40x143		6	4200
RFC	Beam 40x120		8	800

Columns			
Mark	Profile	Count	Length

CM1	Post 80x70	4	2017
CM2	Post 80x70	2	2074

Hans 5 40 (380x575)

Roof 2

② Facia

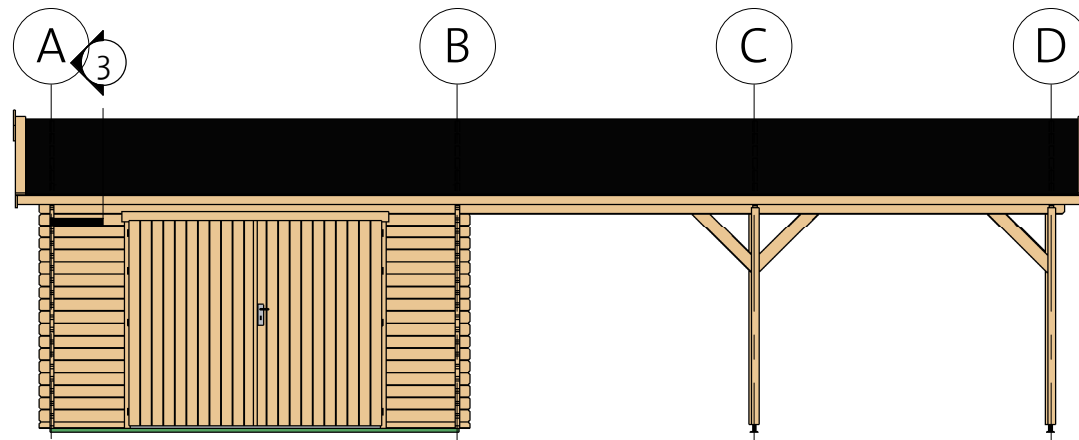
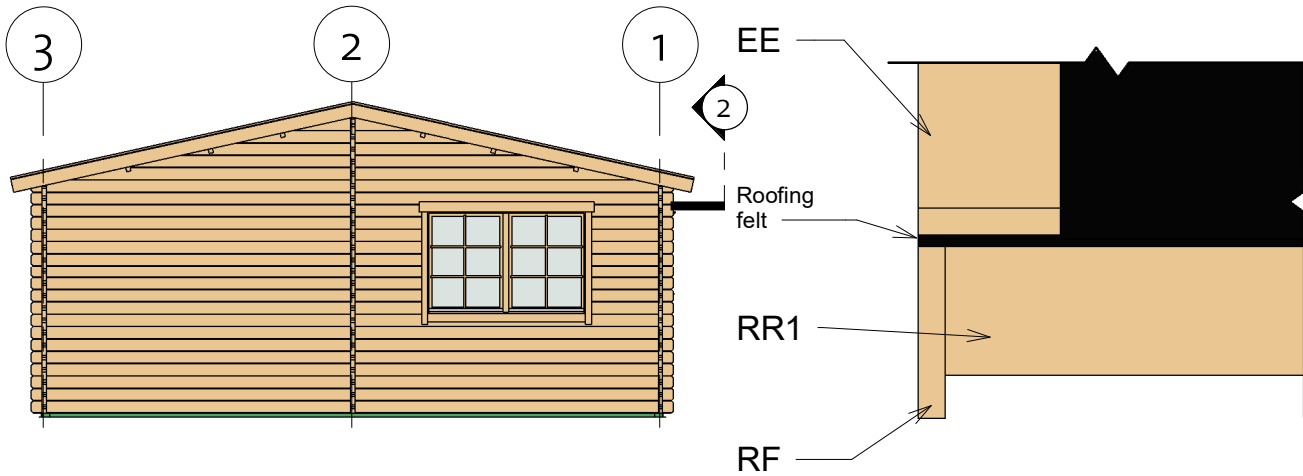

Fascia Schedule				
Mark	Type	Profile	Count	Length
EE	Eave Edging 18x95		4	3238
RF	Roof Fascia 18x120		4	3238
RR1	Roof reinforcement 18x95		4	4950
RR2	Roof reinforcement 38x38		4	4950

③ Roof Reinforcement

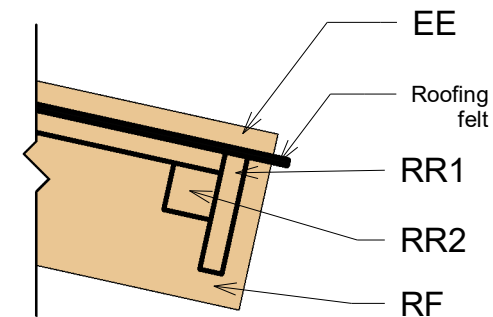

Hans 5 40 (380x575)

Extras

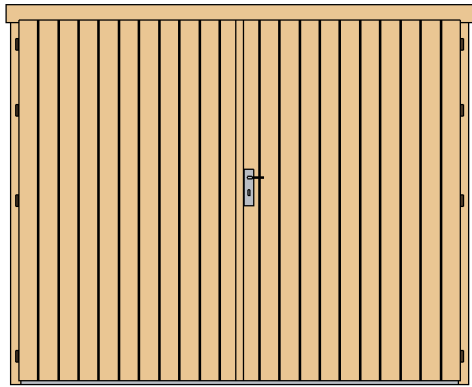

Door Schedule				
Model	Type	Width	Height	Count
CDD10R	Classic double door 10, wood right	2370	1955	1
CD1R	Classic door 1 right	840	1890	1

DCB6	Door Crossbar 6	--	--	1
------	-----------------	----	----	---

Fasteners/Extras		
Name	Type	Count

Hitblock	300-400 mm	
Adjustable post foot		6
Bolts	M8x70	12
Dowels	16,0 x 150	20
Screws	5,0 x 70	35
Screws	6,0 x 140	80
Screws	4,0 x 40	200
Screws	4,0 x 50	950



Window Schedule				
Mark	Type	Width	Height	Count
CDW1	Classic double window 1	1530	990	1

WCB6	Windows Crossbar 6	--	--	2
------	--------------------	----	----	---

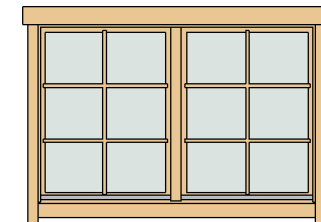

Type	Count	Length
Windboard 18x40	4	2200

Type	Count
Romb	2



92111021_210405

Hans 5 40 (380x575)

List of all items 1



Impregnated foundation beams

Mark	Type	Profile	Count	Length
IFB1	IFB 70x40		2	5600
IFB2	IFB 70x40		2	3790
IFB3	IFB 70x40		2	120





Columns

Mark	Profile	Count	Length
CM1	Post 80x70	4	2017
CM2	Post 80x70	2	2074

Roof

Mark	Type	Profile	Count	Length
RB	17x114		176	3197
RFB1	Beam 40x143		6	5940
RFB2	Beam 40x143		6	4200
RFC	Beam 40x120		8	800

Fascia Schedule

Mark	Type	Profile	Count	Length
EE	Eave Edging 18x95		4	3238
RF	Roof Fascia 18x120		4	3238
RR1	Roof reinforce ment 18x95		4	4950
RR2	Roof reinforce ment 38x38		4	4950

Hans 5 40 (380x575)

List of all items 2

Wall 1			
Mark	Profile	Count	Cut Length

1BL-1	40x57	2	808
1LG-1	40x114	33	808
1LG-2	40x114	1	5620
1LG-3	40x114	1	3880
1LG-4	40x114	1	808
1TL-1	40x114	1	5820
1TL-2	40x114	1	4080

Wall 3			
Mark	Profile	Count	Cut Length

3BL-1	40x57	1	4000
3LG-1	40x114	16	4000
3LG-2	40x114	1	5620
3LG-3	40x114	1	3880
3LG-4	40x114	1	4000
3TL-1	40x114	1	5820
3TL-2	40x114	1	4080

Wall 2			
Mark	Profile	Count	Cut Length

2BL-1	40x57	2	300
2LG-1	40x114	43	300
2LG-2	40x114	1	5620
2LG-3	40x114	1	3880
2LG-4	40x114	1	300
2LG-5	40x114	1	5820
2LG-6	40x114	1	4080
2TL-1	40x57	1	5820
2TL-2	40x57	1	4080

Hans 5 40 (380x575)

List of all items 3

Wall A			
Mark	Profile	Count	Cut Length

ALG-1	40X114	9	778
ALG-2*	40X114	1	1032
ALG-3*	40X114	1	2063
ALG-4*	40X114	1	3093
ALG-5	40X114	9	3633
ALG-6*	40X114	1	4124
ALG-7*	40X114	1	5155
ALG-8	40X114	10	5950
ALG-9*	40X114	1	5950

Wall B			
Mark	Profile	Count	Cut Length

BLG-1	40X114	17	500
BLG-2*	40X114	1	1032
BLG-3*	40X114	1	2063
BLG-4*	40X114	1	3093
BLG-5*	40X114	1	4124
BLG-6	40X114	17	4600
BLG-7*	40X114	1	5155
BLG-8	40X114	2	5950
BLG-9*	40X114	1	5950

Wall C			
Mark	Profile	Count	Cut Length

CLG-1*	40X114	1	1032
CLG-2*	40X114	1	2063
CLG-3*	40X114	1	3093
CLG-4*	40X114	1	4124
CLG-5*	40X114	1	5155
CLG-6	40X114	1	5950
CLG-7*	40X114	1	5950

Wall D			
Mark	Profile	Count	Cut Length

DLG-1 *	40X114	1	1032
DLG-2 *	40X114	1	2063
DLG-3 *	40X114	1	3093
DLG-4*	40X114	1	4124
DLG-5*	40X114	1	5155
DLG-6	40X114	1	5950
DLG-7*	40X114	1	5950

Log profiles	
Profile	Profile

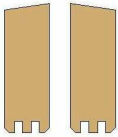
40X57	
40X114	

* Gable - delivered premounted

Log profiles	
Profile	Profile

40X114	
40X57	